

VT6 30 SERIES ROBOT DRESS PACK

Assembly Instruction

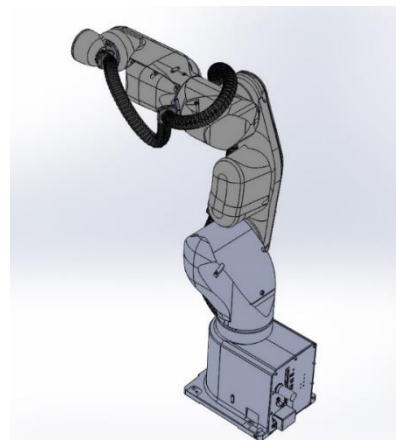

SCHNEIDER & COMPANY

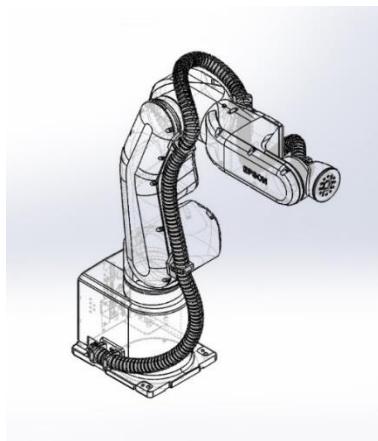
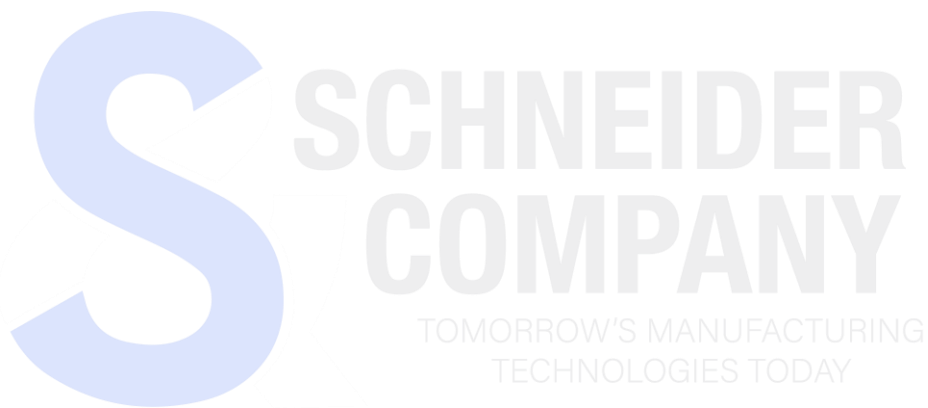

Contact Information

Website: www.schneider-company.com

Address: 10503 Citation Drive #600, Brighton, MI 48116

Phone: 810-360-0596

Email: sales@schneider-company.com

Warranty

Every attempt has been made to deliver a quality product that will give you years of trouble-free service. For any inquiries or complaints regarding a defect of workmanship or materials please use the contact details listed above at any time.







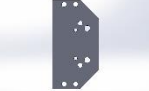

Important Safety Instructions and Recommendations

- Always wear safety glasses when working in proximity of the VT6 robot.
- When installing or removing the pack, it is recommended to turn off the VT6 robot and all other moving fixtures.
- All diagrams rely on the VT6 being oriented using 'pulse 0, 0, 0, 0'

Table of Contents

ASSEMBLY	4
1. Mounting Plate Installation	4
2. Bracket Installation	5
3. Triflex Installation	7
Appendix A – Installed Pack Photos and Videos	9
Appendix B – IGUS 30 Series Official Measurements and Diagrams	10

Included Pack Material

Part Name	Quantity	Picture	Usage Notes
<i>Mounting plate material</i>			
Diamond mounting plate	3		For J1, J2, J3
End of arm mounting plate	1		For end of arm
Base mounting plate	1		For base
Mounting plate screws	12		M4 - 0.7 × 12 - For mounting plates
<i>Bracket material</i>			
Intermediate bracket	4		For J1, J2, J3
Strain relief bracket	2		For base and end of arm
Bracket screws	12		M4 - 0.7 × 10 – For brackets
Wire tie and anchor	1		For location between J2, J3
<i>Triflex material</i>			
Triflex 30 Series	8 ft		Interchangeable with Triflex 40 Series
30 Series Lock Clips	6		For preventing rotation in rigid brackets

ASSEMBLY

1. Mounting Plate Installation

Mounting hole location diagram

The following diagrams indicate the VT6 mounting hole locations and names used in this assembly. Alternative and optional mounts may be used but recommended link counts will no longer fit.

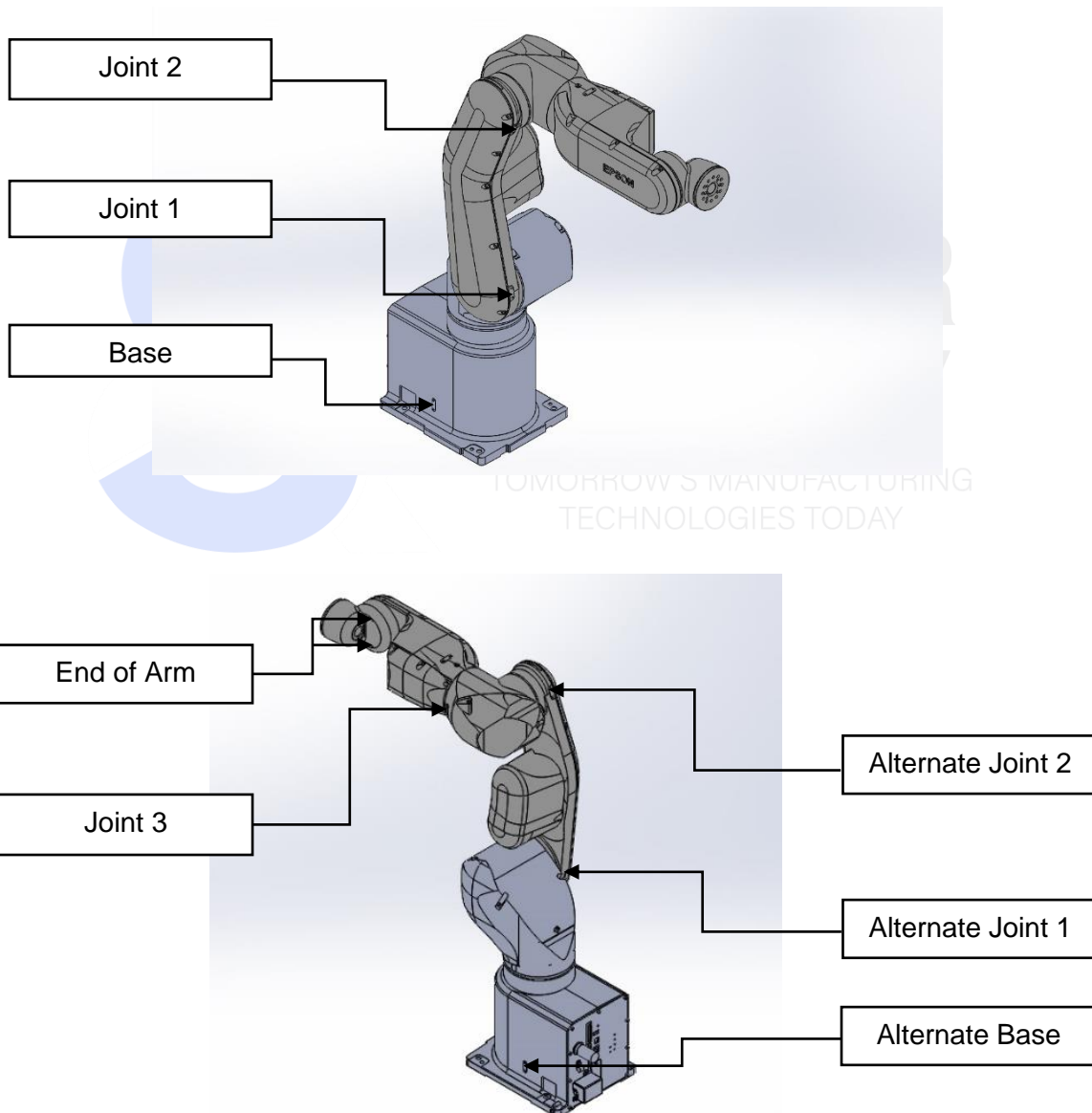

Mounting plate assembly

Note: Diamond mounting plates are non-symmetrical and should be orientated as shown.

Materials Required	Quantity
3mm Allen Key	1
Mounting plate screws	12 (M4 x 12)
End of arm mounting plate	1
Diamond mounting plate	3
Base mounting plate	1

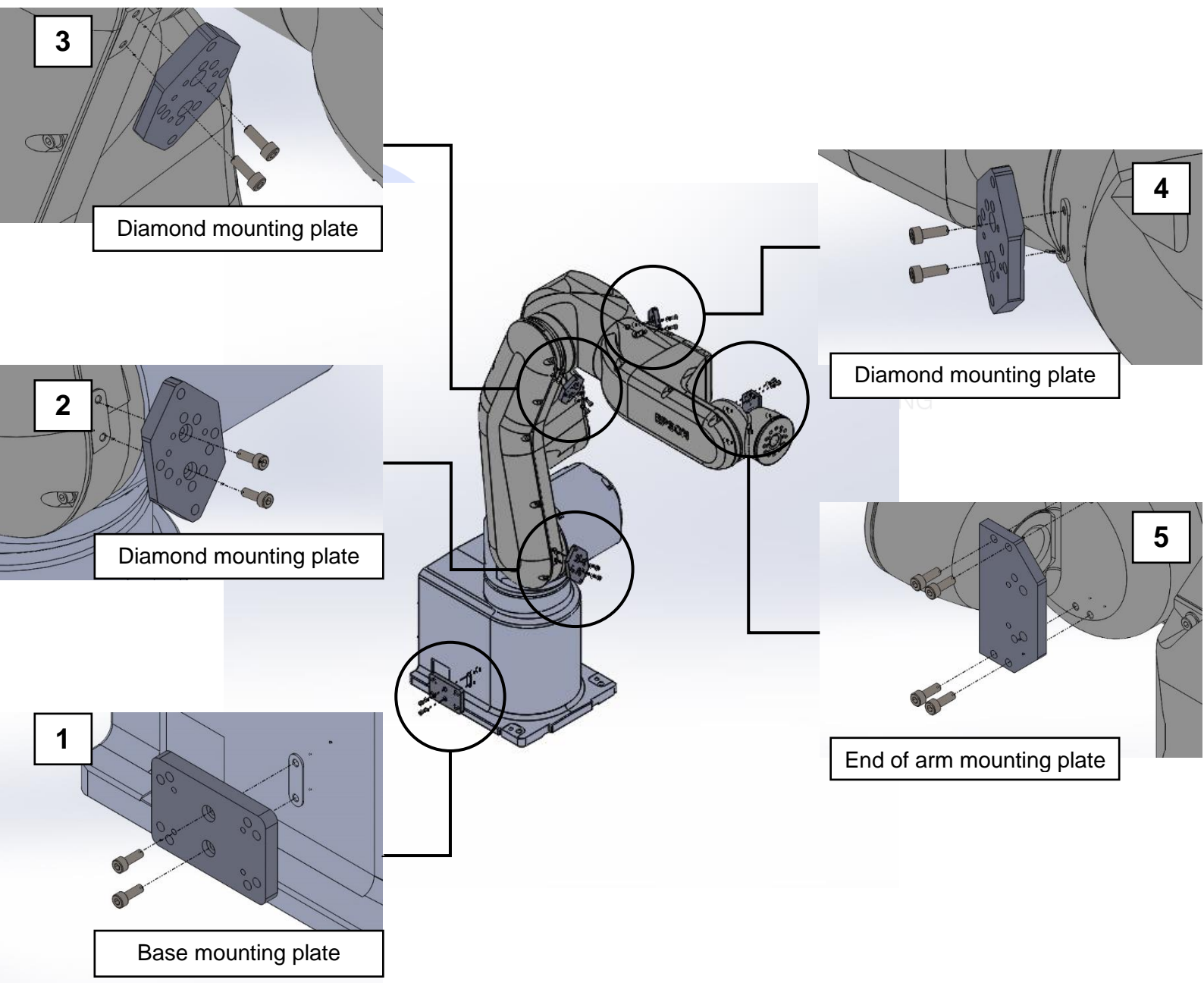

2. Bracket Installation

Bracket assembly

Note: Screws should be fastened from inside the bracket, which may require disassembly of the bracket. (see bracket insert subassembly)

Materials Required	Quantity
5mm allen key	1
Bracket screws	12 (M4 x 10)
Strain relief bracket	2
Intermediate bracket	4

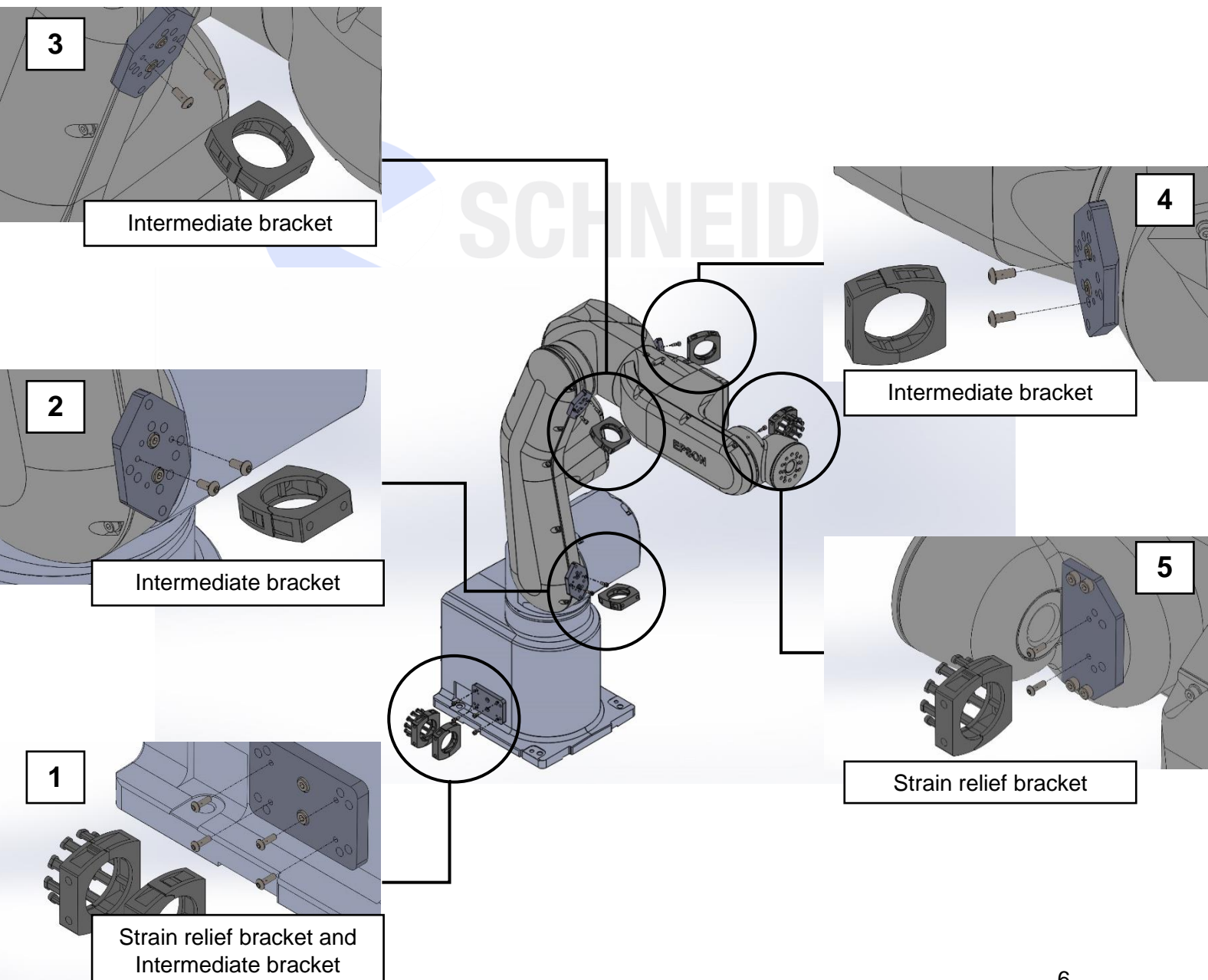

3. Tri-flex 30 Series Installation

Installation best practice

- Clamp brackets on the hard side of Triflex for strength
- Run all cables through outwards facing half of Triflex for ease of access
- Allow Triflex to run without pre-existing torsion before any motion
- Use lock clips in all fixed bracket locations
- It is not recommended to let Triflex be filled with cables beyond 70%
- Connect the Triflex such that the 'ball end' of the tubing is at the End of Arm.
- For more detailed installation instructions:
www.youtube.com/watch?v=Ve2bqkMrXpA

Triflex 30 Series disassembly

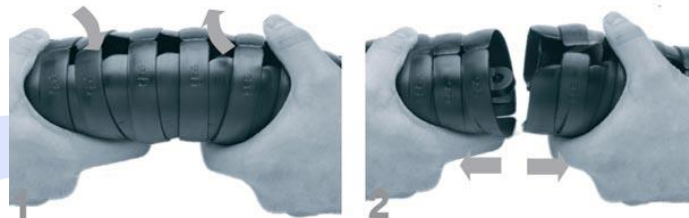

Triflex 30 Series assembly

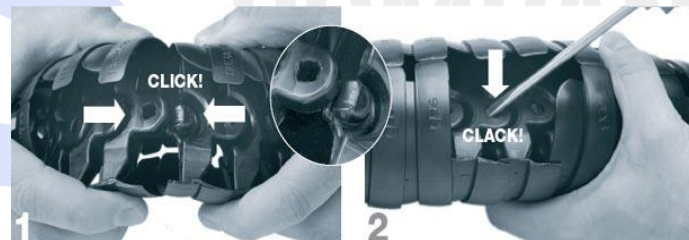

See video at www.igus.com/info/energy-chains-assembly-instructions-triflex-r-tre for further details.

Wire tie anchor

Place the wire tie anchor as depicted in the diagram.

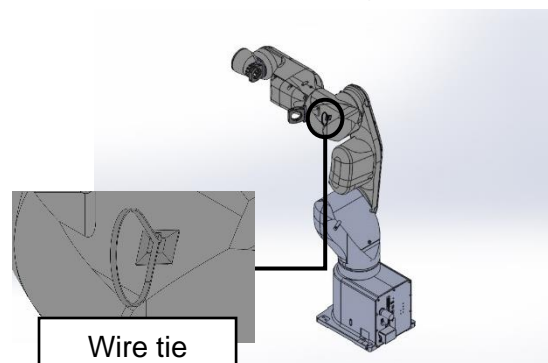

Triflex assembly diagram

Note: Link counts include the links clamped inside the bracket at both the start and end joint. The number of links are intended to allow full range of motion without unreasonable strain or interference.

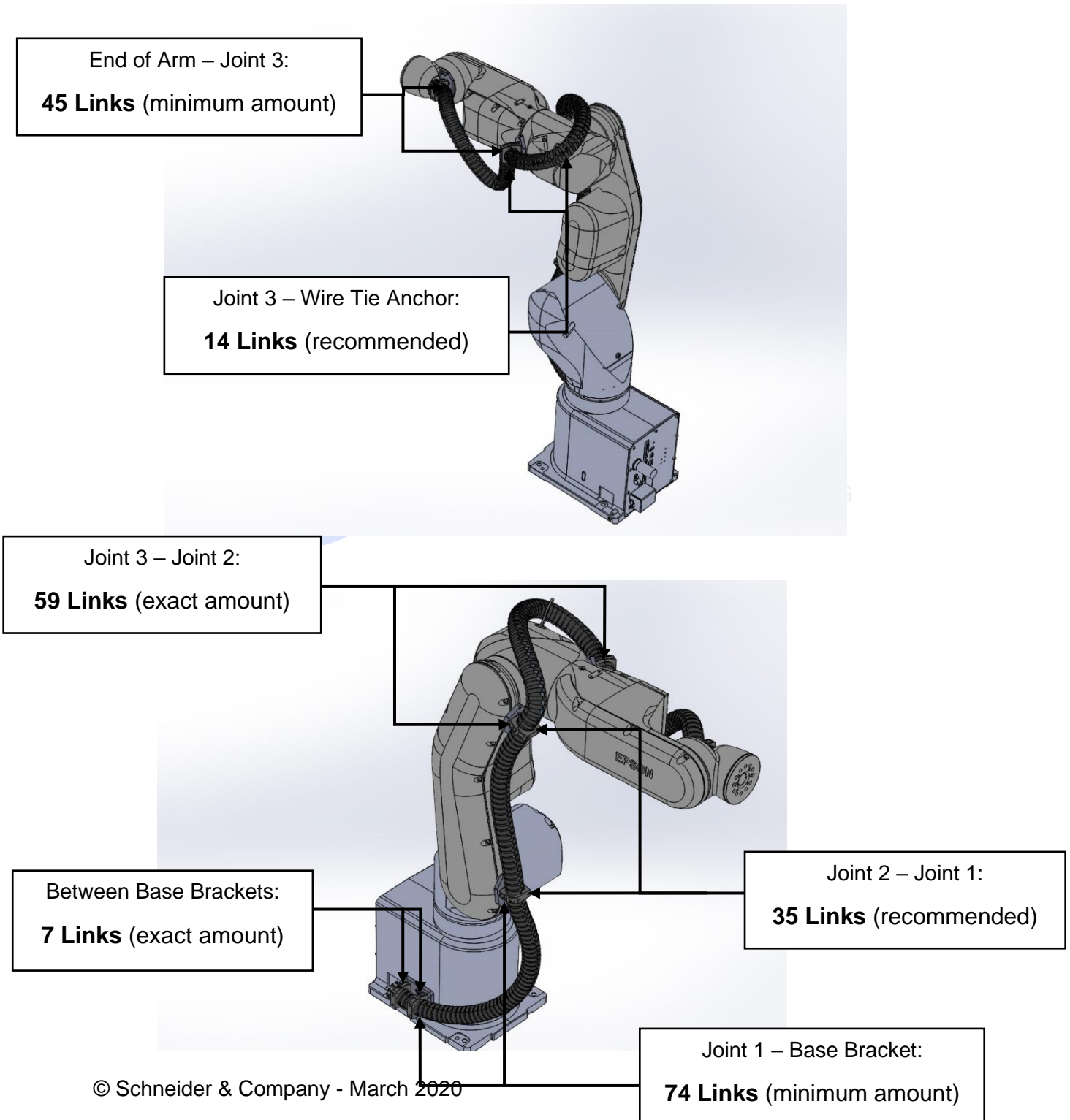

Appendix A – Installed Pack Media



VT6 Dress Pack range of motion demonstration

The following linked video depicts a correct installation of the dress pack and shows that full range of motion is preserved.

<https://tinyurl.com/30SDVideo>



Appendix B –IGUS 30 Series Official Measurements and Diagrams

Installation dimensions

Part No. :	<input type="text" value="TRE-30-050-0"/>
Inner width Bi [inch]:	<input type="text" value="1.2 (30.5 mm)"/>
Bi1 [inch]:	0.47 (12 mm)
Bi2 [inch]:	0.39 (10 mm)
Bending radius R [inch]:	<input type="text" value="1.97 (50 mm)"/>
Chain length [ft]:	<input type="text" value="8"/>
Number of chain links :	219
External width Ba [inch]:	1.36 (34.5 mm)
d1 [inch]:	0.39 (10 mm)
d2 [inch]:	0.31 (8 mm)
Hi [inch]:	1.2 (30.5 mm)
Ha [inch]:	1.36 (34.5 mm)
Weight per link [oz.]:	0.01 (0.249 g)
Weight [lbs/ft]:	0.175 (0.26 kg/m)

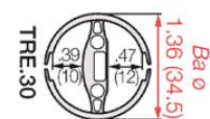
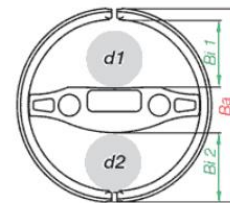

TL-30-XX

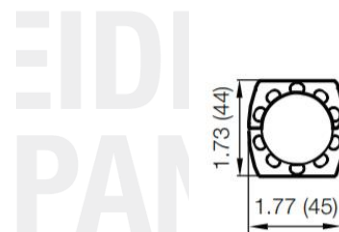

S MANUFACTURING
TECHNOLOGIES TODAY