



## 특징 (Character)

- 랙 & 피니언( 단, AF13-20은 링크 & 레버 타입)  
Rack & Pinion type (AF13-20 is Link & Lever type)
- 바디와 가이드 로드에 의한 2중지지 방식의 견고성  
Strength of double support by body and guide rod
- 다양한 기종으로 폭넓은 선택이 가능  
Wide and various selection possible by various size
- 3방향 취부로 다양한 방법의 취부가 가능  
Mounting possible from 3 sides
- 개폐검출 센서 전기종 부착가능  
Magnetic sensor is available for open-close sensing



AF101

AF02

AF04P

AF105P

AF10

AF13

AF14

AF15

AF316

AF316L

AF416

AF17

AF117

AF24

AF26

AF28D

AF28DS

AF30 (SN)

AF30L

AF46 (SN)

AF56L

RAF56N

MF16

## 랙 & 피니언 방식 (Rack & Pinion type)

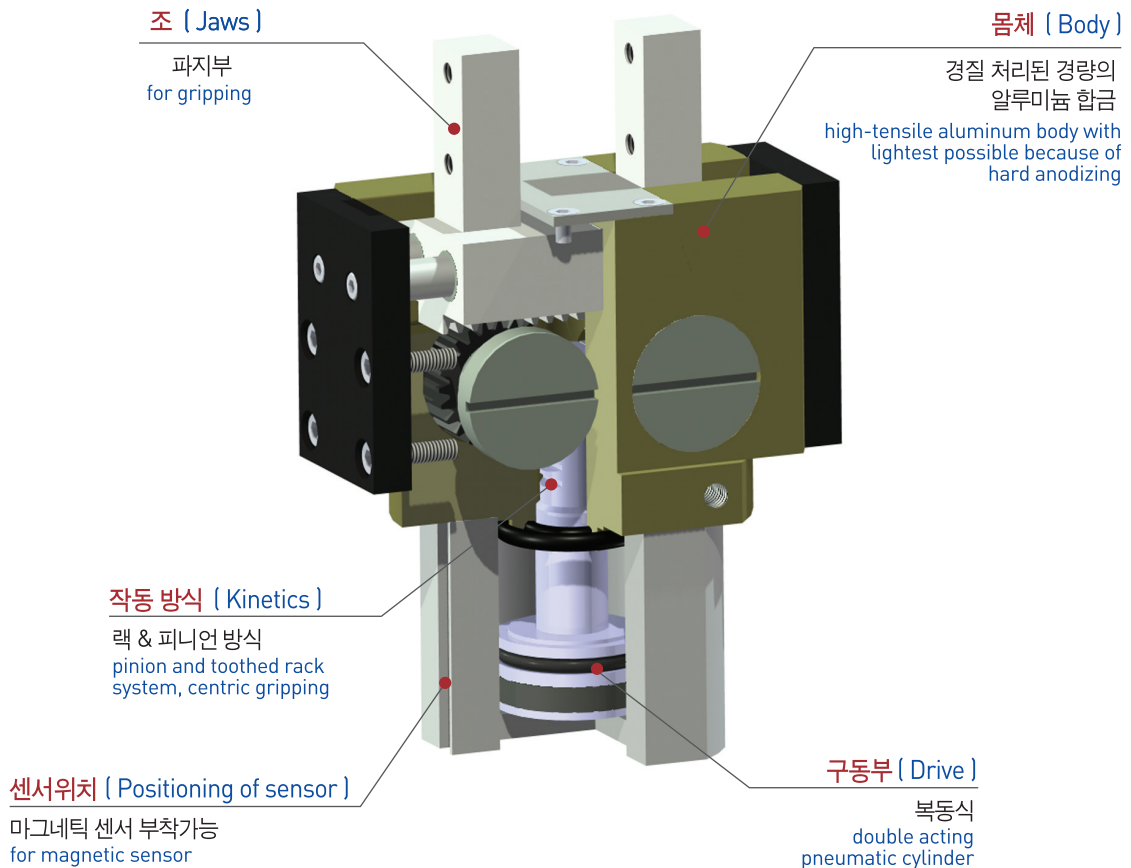

부품분해도 ( Exploded view )

※ 본 분해도는 한 제품을 예시하였으므로 기종별로 차이가 있을 수 있습니다  
 ※ This exploded view illustrates a certain product only. The contents may vary by product models.

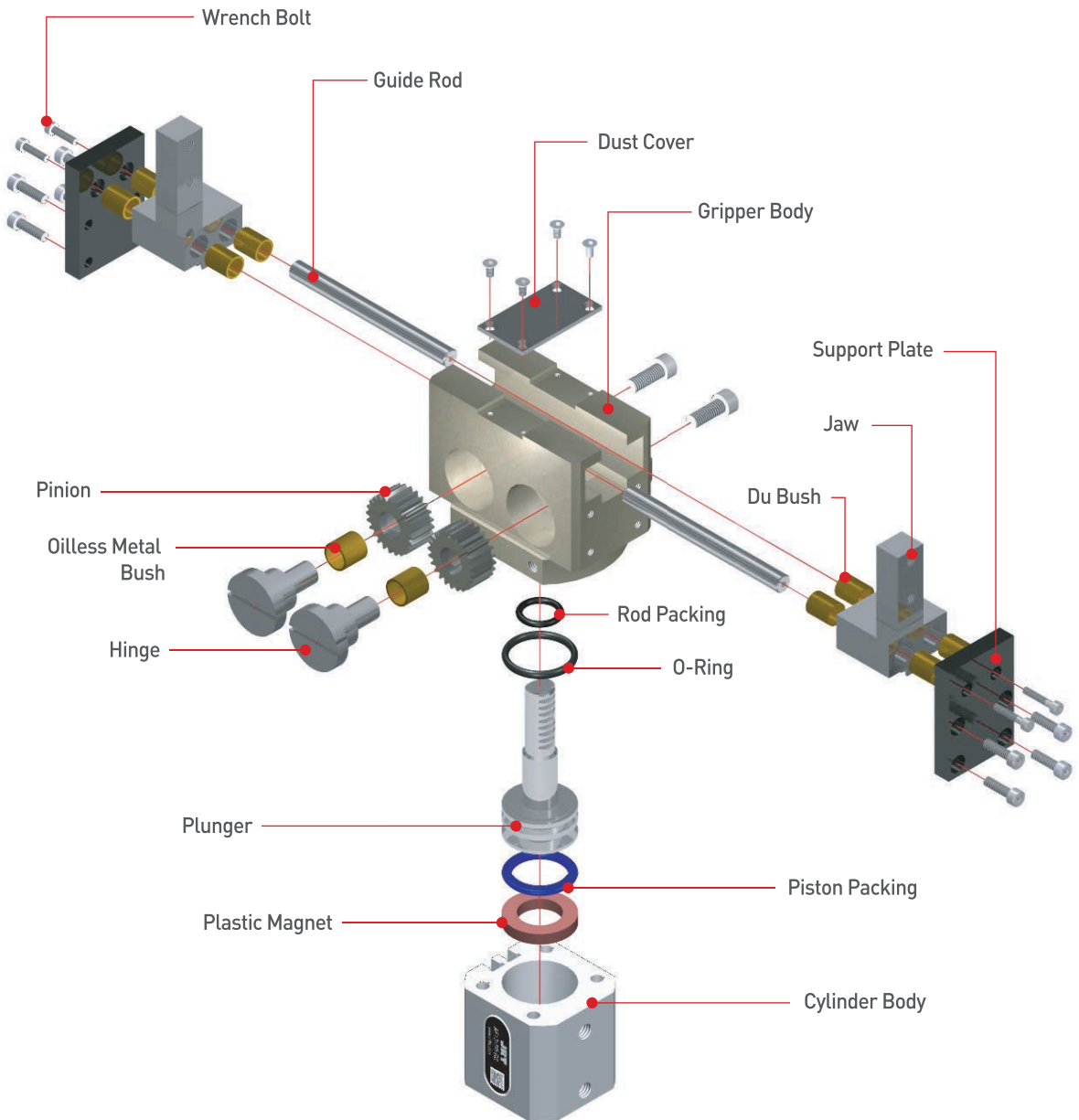

주문기호 ( How to Order )

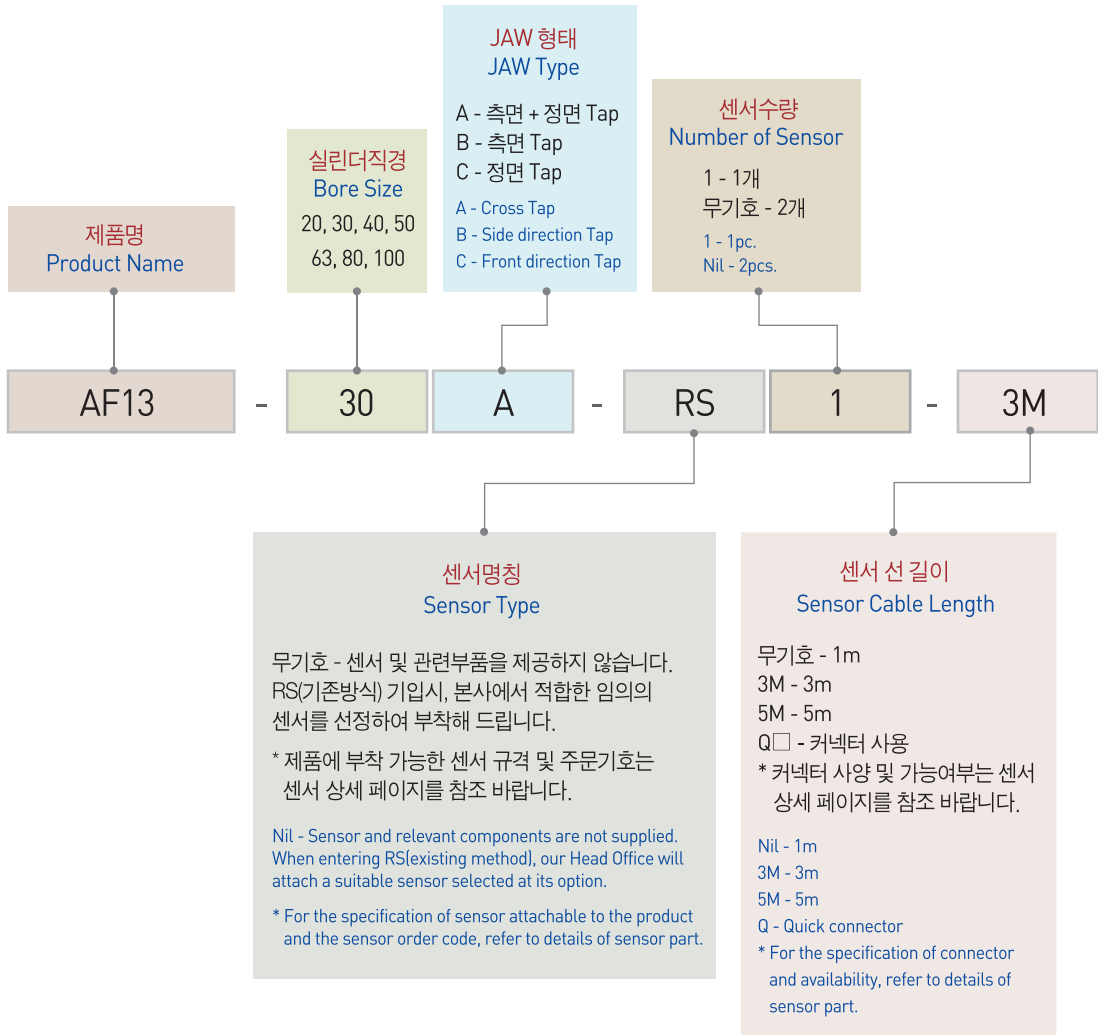

AF101

AF02

AF04P

AF105P

AF10

AF13

AF14

AF15

AF316

AF316L

AF416

AF17

AF117

AF24

AF26

AF28D

AF28DS

AF30 (SN)

AF30L

AF46 (SN)

AF56L

RAF56N

MF16

## ☞ 제품사양 ( Specification )

P=공기압력(bar), L=작용점까지의 거리(mm)  
P = Air Pressure(bar), L = Gripping point distance(mm)

제품명칭 Products Name	AF13-20	AF13-30	AF13-40	단위 Unit
개폐범위 Stroke	12	24	30	mm
제품중량 Weight	0.55	1.3	2.2	kg
최대치구길이 Max. length attach	70	90	110	mm
배관접속구 Fitting size	M5	PF(G) 1/8	PF(G) 1/8	
파지력 : 열림시 Gripping force : Open	24.53P/(1+0.025L)	55.92P/(1+0.02L)	98.10P/(1+0.02L)	N
파지력 : 닫힘시 Gripping force : Close	19.62P/(1+0.025L)	48.07P/(1+0.02L)	83.39P/(1+0.02L)	N
1사이클당 공기소모량 Air consumption per cycle	3.3	15.1	33.9	cm <sup>3</sup>
닫힘시/열림시 시간 Closing / Opening time	0.01/0.01	0.01/0.01	0.01/0.02	sec
반복정밀도 Repeat accuracy	0.03			mm
연속사용회수 Continuation usage amount	60			cpm
사용압력 Operating pressure	3~7			bar
주위온도 Ambient temperature	-5 to 60			℃
윤활 Lubrication	불필요 Needless			

제품명칭 Products Name	AF13-50	AF13-63	AF13-80	AF13-100	단위 Unit
개폐범위 Stroke	36	40	50	60	mm
제품중량 Weight	3.35	5.03	8.29	12.7	kg
최대치구길이 Max. length attach	130	140	150	200	mm
배관접속구 Fitting size	PF(G) 1/8	PF(G) 1/8	PF(G) 1/4	PF(G) 1/4	
파지력 : 열림시 Gripping force : Open	154.02P/(1+0.015L)	242.31P/(1+0.012L)	395.34P/(1+0.01L)	654.33P/(1+0.01L)	N
파지력 : 닫힘시 Gripping force : Close	137.34P/(1+0.015L)	210.92P/(1+0.012L)	350.22P/(1+0.01L)	595.47P/(1+0.01L)	N
1사이클당 공기소모량 Air consumption per cycle	65.0	114.9	235.9	450.0	cm <sup>3</sup>
닫힘시/열림시 시간 Closing / Opening time	0.03/0.04	0.05/0.06	0.11/0.12	0.22/0.23	sec
반복정밀도 Repeat accuracy	0.03				mm
연속사용회수 Continuation usage amount	40	30	30	20	cpm
사용압력 Operating pressure	3~7				bar
주위온도 Ambient temperature	-5 to 60				℃
윤활 Lubrication	불필요 Needless				

반복정밀도 : 연속 100회 작동후 측정치  
After 100 consecutive strokes to end positions

## 작용점에서의 파지력 (Gripping Force From a Point of Action)

범례(Legend) : 7[bar] 5[bar] 3[bar]

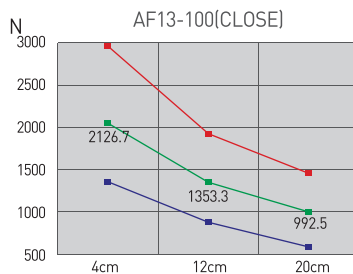
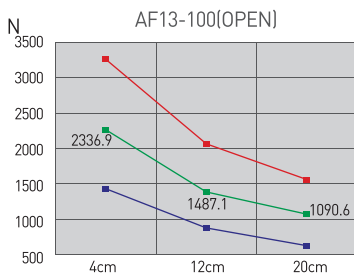
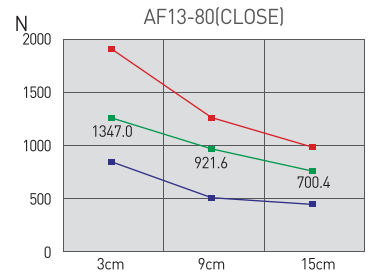
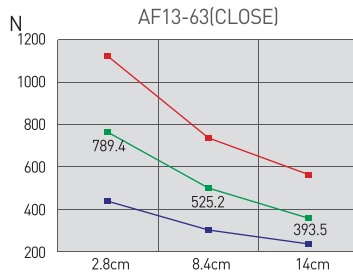
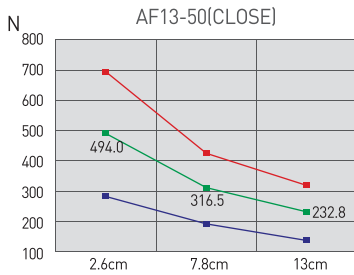
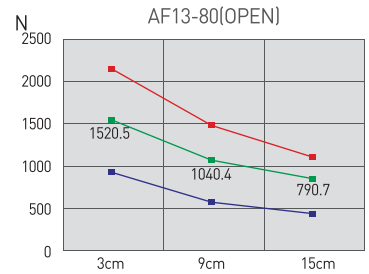
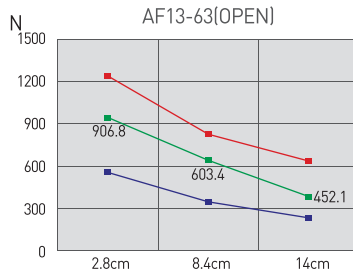
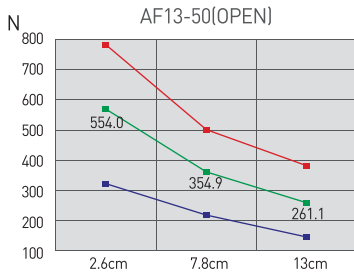
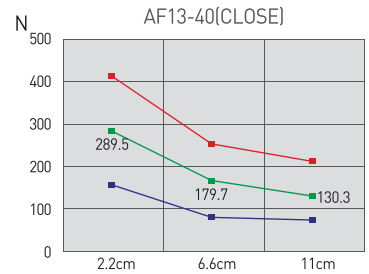
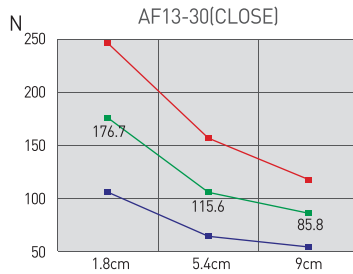
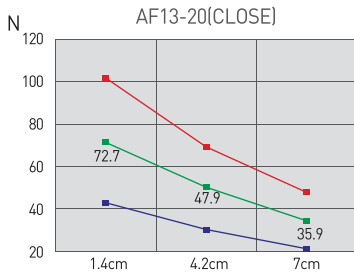
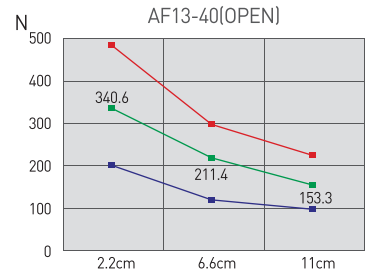
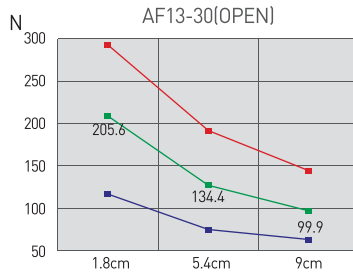
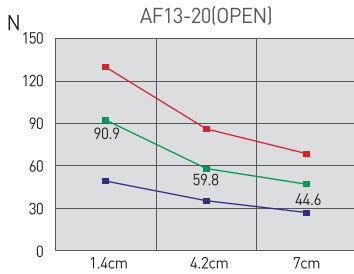

AF101

AF02

AF04P

AF105P

AF10

**AF13**

AF14

AF15

AF316

AF316L

AF416

AF17

AF117

AF24

AF26

AF28D

AF28DS

AF30 (SN)

AF30L

AF46 (SN)

AF56L

RAF56N

MF16

## AF13-20

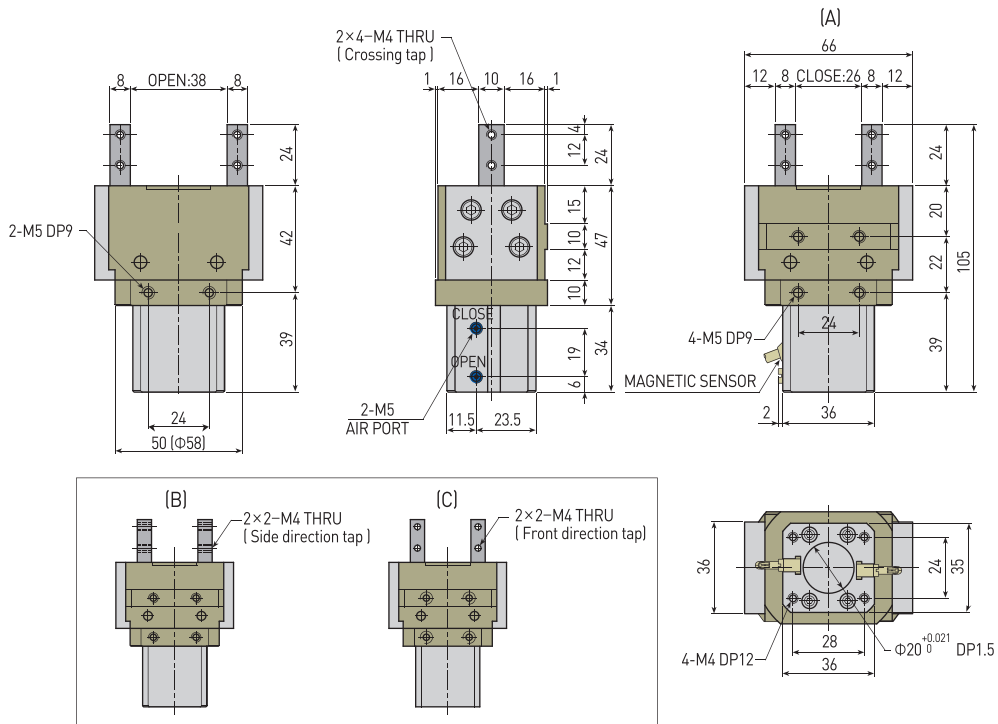

## AF13-30

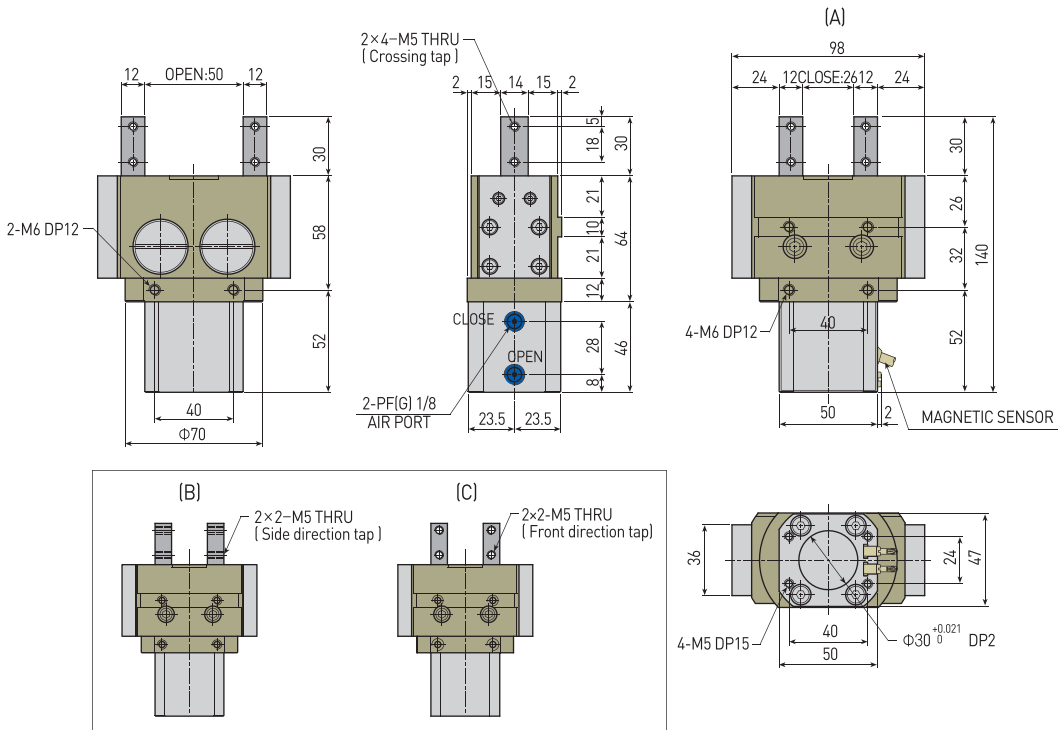

AF13-40

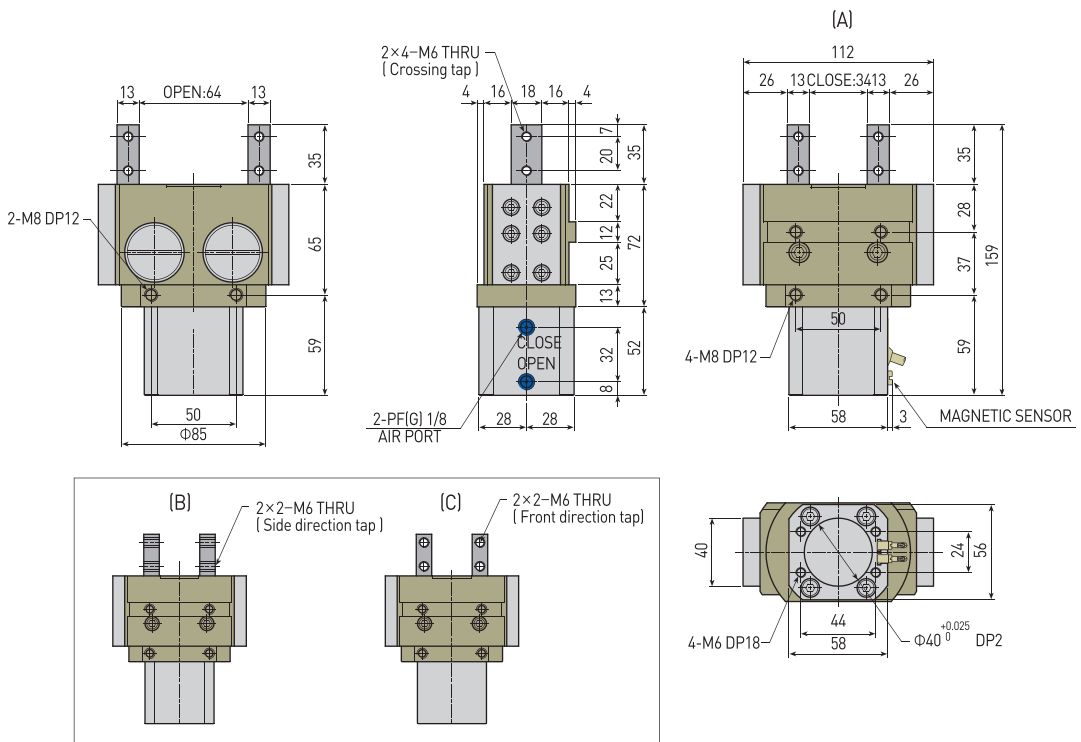

AF13-50

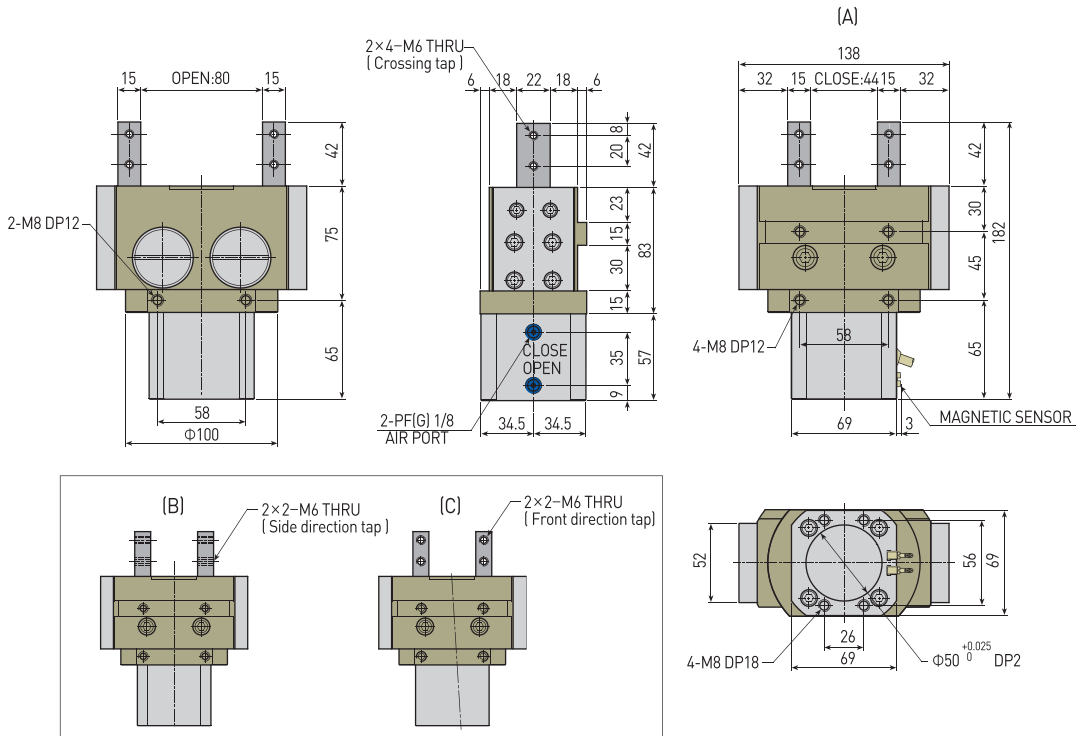

AF101

AF02

AF04P

AF105P

AF10

AF13

AF14

AF15

AF316

AF316L

AF416

AF17

AF117

AF24

AF26

AF28D

AF28DS

AF30 (SN)

AF30L

AF46 (SN)

AF56L

RAF56N

MF16

## AF13-63

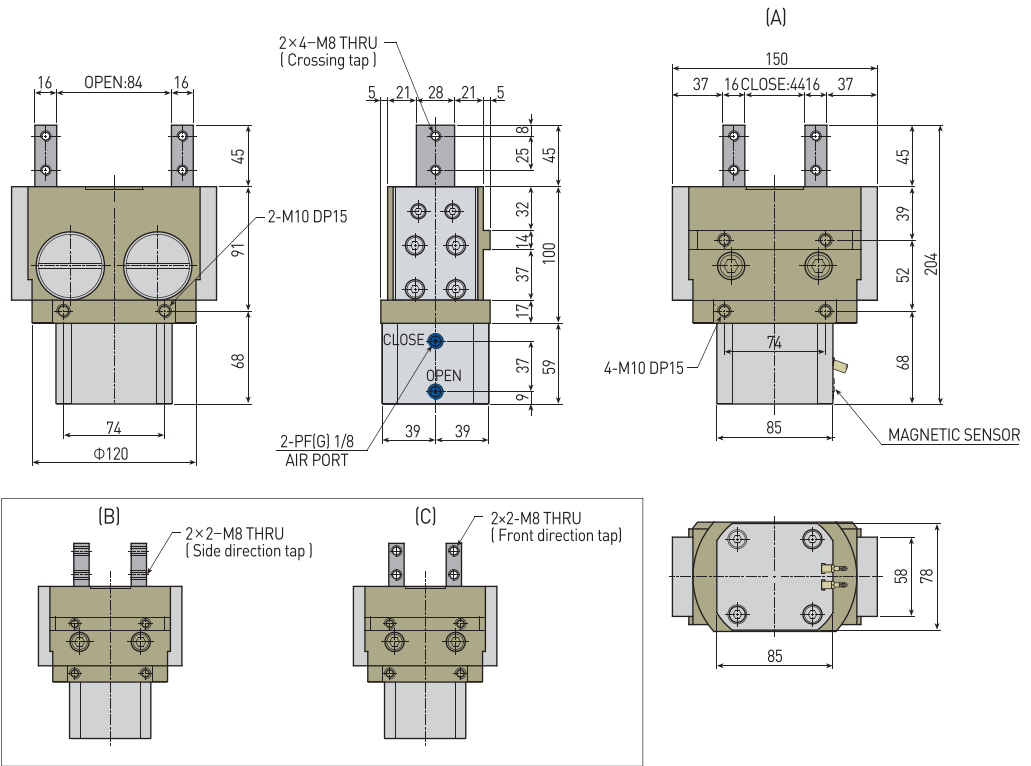

## AF13-80

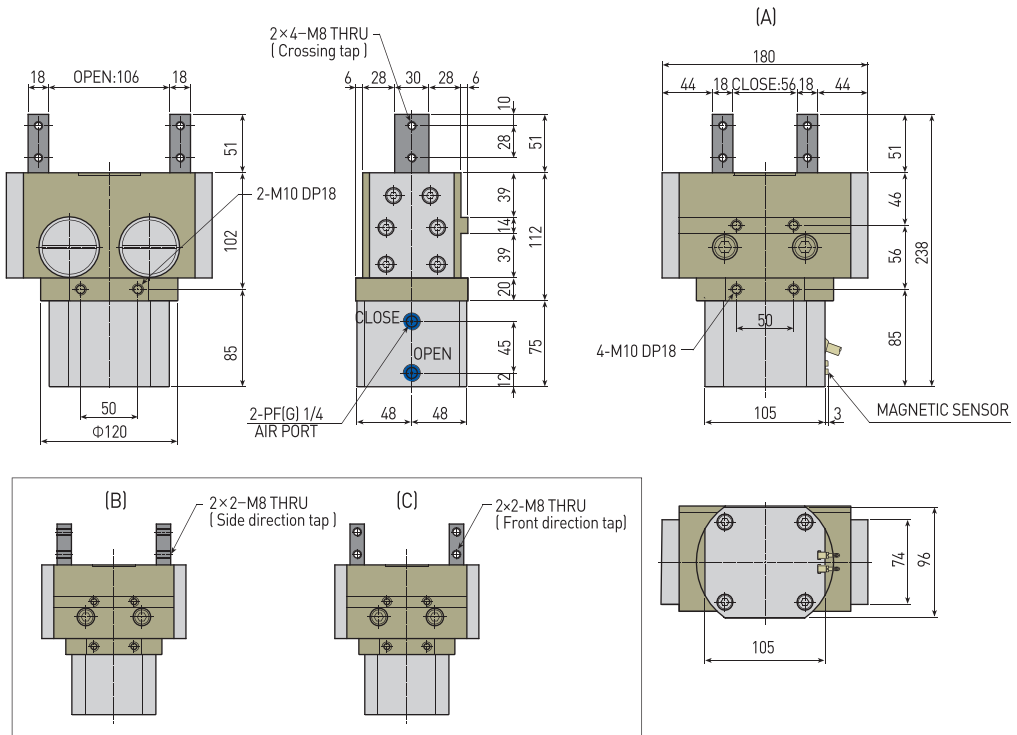



AF13-100

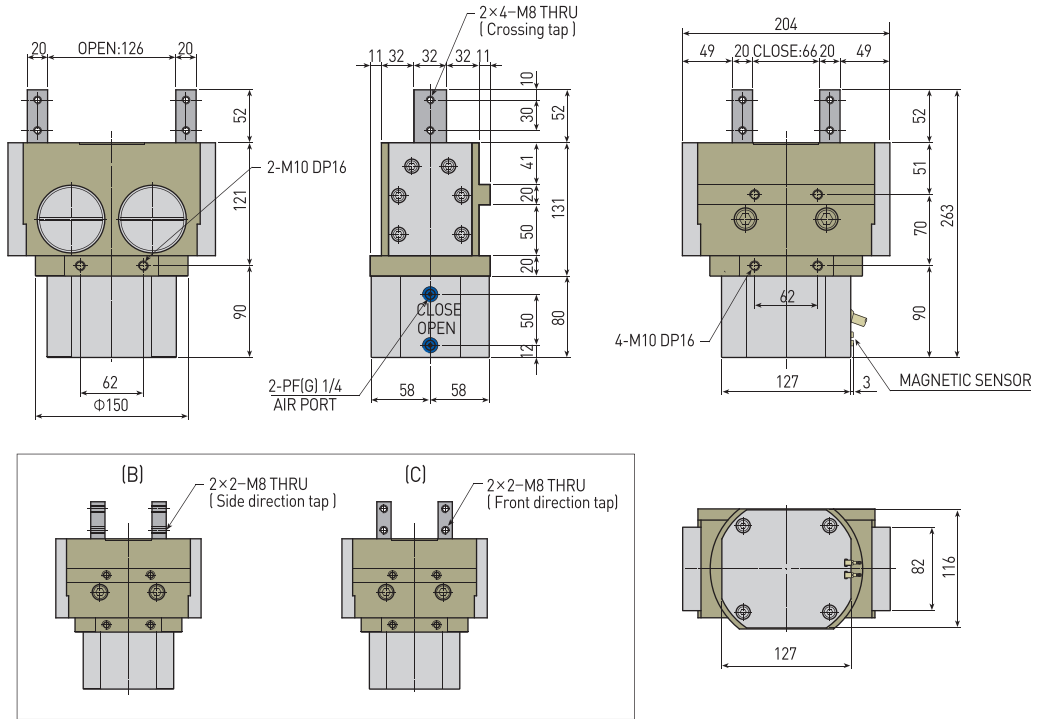

NOTE

AF101

AF02

AF04P

AF105P

AF10

AF13

AF14

AF15

AF316

AF316L

AF416

AF17

AF117

AF24

AF26

AF28D

AF28DS

AF30 (SN)

AF30L

AF46 (SN)

AF56L

RAF56N

MF16